

# UUS ACO Multipoint B 125 trapp

## ACO toote eelised

- Valmistatud vastupidavast polümeerbetoonist
- Kruvideta Drainlock restide lukustus
- Moodulsüsteem suure restivalikuga

- Vastab standarditele DIN EN 124-2/ DIN EN 124-3
- Raskusklassid A 15 – B 125
- NBR-st valmistatud huulik-labürint-tihendiga vedelikkindlaks ühendamiseks maandustoruga DN/OD 110
- Äravoolutrappi saab täielikult täielikult tühjendada tänu 2-kradistele kaldelele
- Komplektis mudakorv (3,1 liitrit)
- Valikuliselt EN-GJS malmist või tsingitud terasest sissevalatava raamiga



Välismõõdud			Kaal	Tootekood	Hind
Pikkus	Laius	Kõrgus			
[mm]	[mm]	[mm]	[kg]		[EUR KM-ta]

### Malmäärega

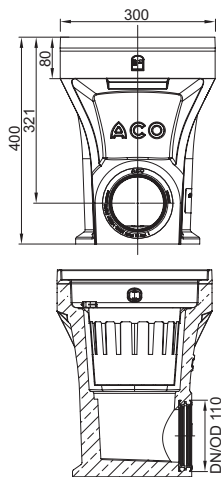

300 300 400 24,9

152903

125,-

14

### Tsingitud äärega

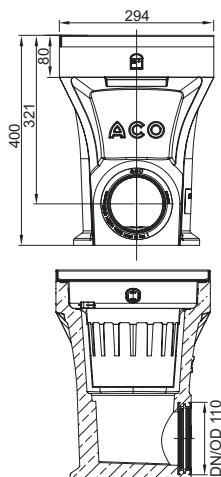

294 294 400 22,9



152902

125,-





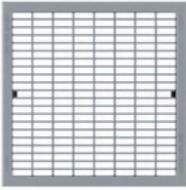
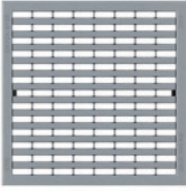

# Restid

## Raskusklass B 125

- Restid vastavad standarditele DIN EN 124-2/DIN EN 124-3
- Kruvideta Drainlock restide lukustus
- Reste saab optimaalseks joendamiseks pöörata 90 kraadi

	Raskus- klass	Materjal	Mõõtmed		Sissevooluava	Sissevoolu	Kaal	Tootekood	Hind
			Pikkus	Laius	mõõt	läbilõige			
			[mm]	[mm]	[mm]	[cm <sup>2</sup> /m]			
<b>Malmrest</b>									
	B 125	Malm EN-GJS	281	281	10	219	6,7	152912	95,-
<b>Voronoi rest</b>									
	B 125	Malm EN-GJS	281	281	–	235	6,1	3005514	95,-
<b>Võrkrest</b>									
	B 125	Tsingitud teras	281	281	9 x 28	426	3,4	152910	75,-
<b>Pikisuunaline profiilrest</b>									
	B 125	Tsingitud teras	281	281	9	263	3,1	152911	85,-

## Lisatarvikud

	Kirjeldus	Sobib moodulile	Kaal [kg]	Tootekood	Hind [EUR KM-ta]
	<b>Kõrgenduselement malmraamiga</b> <ul style="list-style-type: none"> <li>■ Integreeritud malmraamiga EN-GJS</li> <li>■ Raskusklass B 125</li> <li>■ Polümeerbetoonist</li> <li>■ Horisontaalse äravoolutoru DN/OD 110 ühendamiseks</li> <li>■ Huulik-labürinttihendiga</li> <li>■ Kõrgus: 232 mm</li> </ul>	<ul style="list-style-type: none"> <li>■ Multipoint B 125</li> </ul>	13,8	152921	120,-
	<b>Kõrgenduselement tsingitud raamiga</b> <ul style="list-style-type: none"> <li>■ Integreeritud tsingitud terasest raamiga</li> <li>■ Raskusklass B 125</li> <li>■ Polümeerbetoonist</li> <li>■ Horisontaalse äravoolutoru DN/OD 110 ühendamiseks</li> <li>■ Huulik-labürinttihendiga</li> <li>■ Kõrgus: 232 mm</li> </ul>	<ul style="list-style-type: none"> <li>■ Multipoint B 125</li> </ul>	11,8	152920	120,-
	<b>Haisulukk</b> <ul style="list-style-type: none"> <li>■ Veesamba kõrgus 50 mm</li> <li>■ Roostevaba teras</li> </ul>	<ul style="list-style-type: none"> <li>■ Multipoint B 125</li> <li>■ Multipoint D 400</li> </ul>	0,6	319642	55,-
	<b>Liivapüüduuri haisulukk</b> <ul style="list-style-type: none"> <li>■ PP</li> <li>■ DN/OD 110</li> </ul>	<ul style="list-style-type: none"> <li>■ Liivapüüdurid äravooluga DN/OD 110</li> <li>■ Multipoint B 125</li> </ul>	0,2	01684	17,-
	<b>Filterkott mudakorvile</b>	<ul style="list-style-type: none"> <li>■ Multipoint</li> </ul>	0,1	16129	20,-
<b>Lisatarvik restidele</b>					
	<b>Restikonks</b> <ul style="list-style-type: none"> <li>■ Restide väljatõstmiseks</li> <li>■ Tsingitud teras</li> </ul>	<ul style="list-style-type: none"> <li>■ Restid</li> </ul>	0,3	3000679	30,-

# UUS ACO Multipoint D 400 trapp

## ACO toote eelised

- Äravoolutrapp laiade kasutusvõimalustega
  - 360 graadi pööratav
  - 30 mm reguleeritava kõrgusega
  - 3 protsenti kallutatav
- Valmistatud vastupidavast polümeerbetoonist
- Kruvideta Drainlock restide lukustus
- Moodulsüsteem suure restivalikuga

- Vastab standardile DIN EN 124-2
- Raskusklassid A 15 – D 400
- Integreeritud raamiga (malm EN-GJS)
- Äravoolutrapp tühjeneb täielikult tänu 2-kradistele kalletele
- Mudakorv komplektis



## Multipoint D 400 – kõrge trapp

- NBR-st valmistatud huulte labürinttihendiga vedelikukindlaks ühendamiseks maandustoruga DN/OD 110
- Mudakorv komplektis (2,6 liitrit)
- Ülemine osa pööratav, kallutatav ja reguleeritava kõrgusega

Välismõõdud			Kaal	Tootekood	Hind
Pikkus	Laius	Kõrgus			
[mm]	[mm]	[mm]	[kg]		[EUR KM-ta]

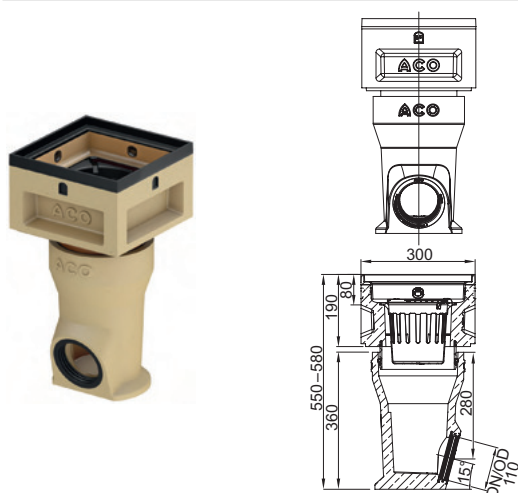

300	300	550–580	28,5	152906	175,-
-----	-----	---------	------	--------	-------

## Multipoint D 400 – madal trapp

- Vertikaalse äravooluga DN/OD 160
- Mudakorv komplektis (1,1liitrit)
- Madal paigaldussügavus

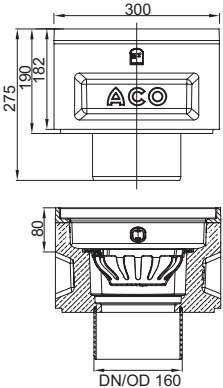
	Välismõõdud			Kaal [kg]	Tootekood	Hind [EUR KM-ta]
	Pikkus [mm]	Laius [mm]	Kõrgus [mm]			
	 	300	300			

## Restid

### Raskusklass B 125/D 400

- Restid vastavad standarditele DIN EN 124-2/DIN EN 124-3
- Kruideta Drainlock restide lukustus
- Reste saab optimaalseks joendamiseks pöörata 90 kraadi

	Raskus- klass	Materjal	Mõõtmed		Sissevooluava	Sissevoolu	Kaal [kg]	Tootekood	Hind [EUR KM-ta]
			Pikkus [mm]	Laius [mm]	mõõt [mm]	läbilõige [cm <sup>2</sup> /m]			

#### Malmrest



B 125	Malm EN-GJS	281	281	10	219	6,7	152912	95,-
-------	----------------	-----	-----	----	-----	-----	--------	------

#### Voronoi rest



B 125	Malm EN-GJS	281	281	–	235	6,1	3005514	95,-
-------	----------------	-----	-----	---	-----	-----	---------	------

	Raskus- klass	Materjal	Mõõtmed		Sissevooluava mõõt	Sissevoolu läbilõige	Kaal	Tootekood	Hind
			Pikkus	Laius					
			[mm]	[mm]	[mm]	[cm <sup>2</sup> /m]	[kg]	[EUR KM-ta]	

### Võrkrest

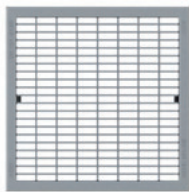

B 125	Tsingitud teras	281	281	9 x 28	426	3,4	152910	75,-
-------	-----------------	-----	-----	--------	-----	-----	--------	------

### Pikiprofiilrest

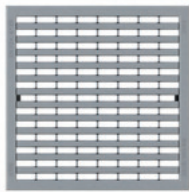

B 125	Tsingitud teras	281	281	9	263	3,1	152911	85,-
-------	-----------------	-----	-----	---	-----	-----	--------	------

### Malmrest D 400



D 400	Malm EN-GJS	281	281	14 x 33	244	9,0	152913	99,-
-------	-------------	-----	-----	---------	-----	-----	--------	------

## Lisatarvikud

	Kirjeldus	Sobib moodulile	Kaal	Tootekood	Hind
			[kg]		[EUR KM-ta]
	<b>Haisulukk</b> ■ Veesamba kõrgus 50 mm ■ Roostevaba teras	■ Multipoint B 125 ■ Multipoint D 400	0,6	319642	72,-
	<b>Vahetükk</b> ■ Kõrgus: 290 mm ■ Polümeerbetoon	■ Multipoint D 400 kõrge trapp	8,3	319606	73,-
	<b>Restikonks</b> ■ Restide väljatõstmiseks ■ Tsingitud teras	■ Restid	0,3	3000679	30,-
	<b>Polüesterliim</b> ■ Kohapealseks liimimiseks ■ Maht: 0,5 kg	■ Polümeerbetoonist elementide liimimiseks	0,9	02163	49,-
	<b>Filterkott mudakorvile</b>	■ Multipoint	0,1	16129	20,-